



















27 808 980



Passt zu: IMO, MEM, CL.1, CYO

- COMPACT RAIN, Durchfluss max. 6,8 l/min (bei 3 Bar)
- mit Antikalk-System
- Brauseabgang 3/8"
- Rosette für Wandanschlussbogen 60 x 60 mm
- Rosette für Brausehalter 60 x 60 mm
- Metallbrauseschlauch 1250 mm mit integriertem Verdreherschutz
- Wandanschlussbogen 1/2"
- Dieses Produkt leistet einen Beitrag zur Erfüllung der Vorgaben von nachhaltigen Gebäudezertifizierungen, z.B. LEED®, BREEAM®, DGNB

Eigensicher gegen Rückfließen.

	Chrom gebürstet	27 808 980-93 0010
	Chrom	27 808 980-00
	Chrom	27 808 980-00 0010
	Platin gebürstet	27 808 980-06
	Platin gebürstet	27 808 980-06 0010
	Platin	27 808 980-08
	Platin	27 808 980-08 0010
	Dark Chrome	27 808 980-19
	Dark Chrome	27 808 980-19 0010
	Messing gebürstet (23kt Gold)	27 808 980-28 0010
	Messing gebürstet (23kt Gold)	27 808 980-28
	Schwarz matt	27 808 980-33
	Schwarz matt	27 808 980-33 0010
	Champagne gebürstet (22kt Gold)	27 808 980-46 0010
	Champagne (22kt Gold)	27 808 980-47 0010
	Chrom gebürstet	27 808 980-93
	Dark Platin gebürstet	27 808 980-99
	Dark Platin gebürstet	27 808 980-99 0010

27 808 980

mm [inches]

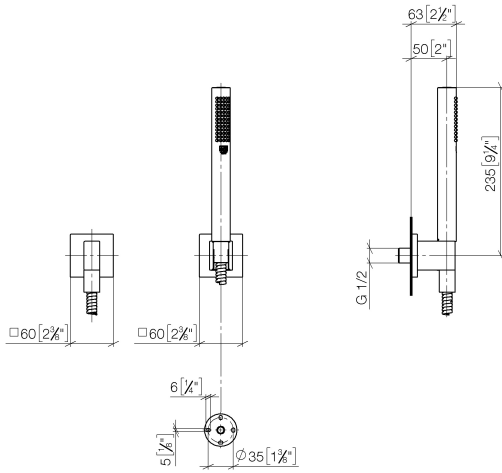

Durchflussdiagramm

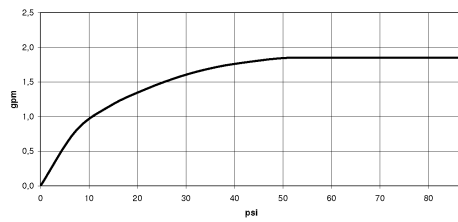

Zertifikate

LGA_29985.

IAPMO_4976 (2).

27 808 980

Ersatzteile für die
anderen
Oberflächenvarianten
finden Sie hier:
Chrom

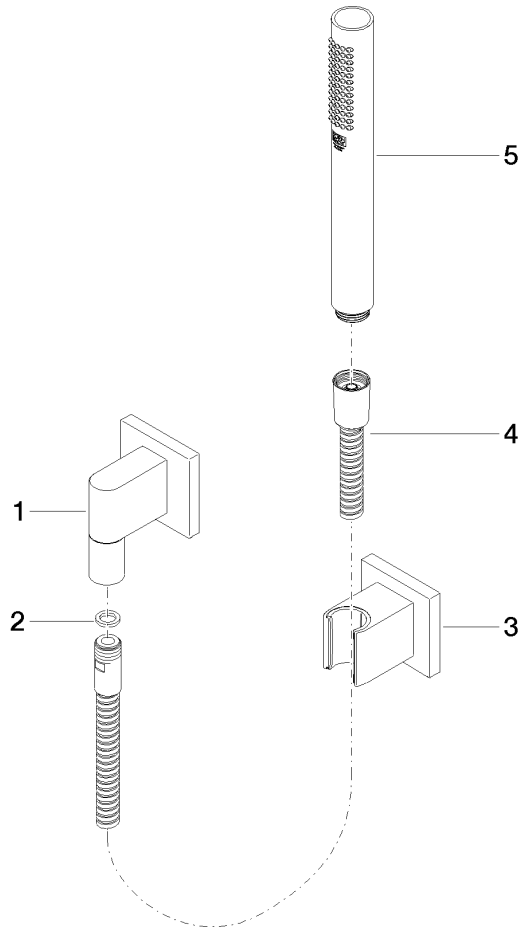

Ersatzteilstückliste

Nr.	Artikelnummer	Benennung	Verbaumenge	Lieferzeit
1	28 450 980-93	Wandanschlussbogen - Chrom gebürstet	1	10
2	90 14 20 026 00 90	Dichtung	1	2
3	28 050 980-93	Brausehalter - Chrom gebürstet	1	20
4	90 30 02 072 00-93	Metall-Brauseschlauch 1/2" x 3/8" x 1250 mm - Chrom gebürstet	1	20
5	90 12 11 140 30-93	Brause	1	20